

# TRENDNET®



## Quick Installation Guide

TV-NVR408 / TV-NVR416 (V1)

# Table of Content

---

## **1 English**

1. Installation
2. Overview
3. Start Recording
4. Instant Playback

# 1. Installation

## Package Contents

- TV-NVR408/TV-NVR416
- Power Cord (1.4m / 5 ft.)
- Network Cable (1.8m / 6ft)
- HDMI Cable (1.8m / 6ft)
- Optical Mouse
- SATA Data Cables / power Cables
- Quick Installation Guide
- Rack mount hardware

## Minimum System Requirements

- Monitor/TV with VGA or HDMI connection

## Back Panel

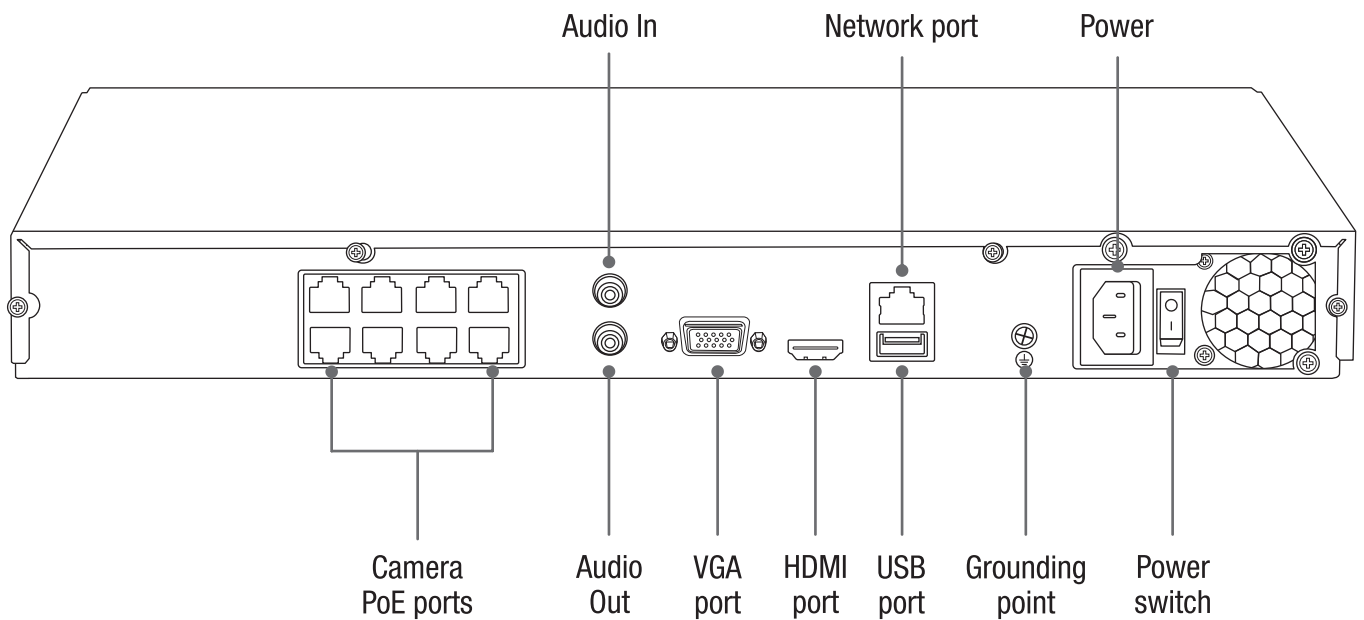

## 2. Overview

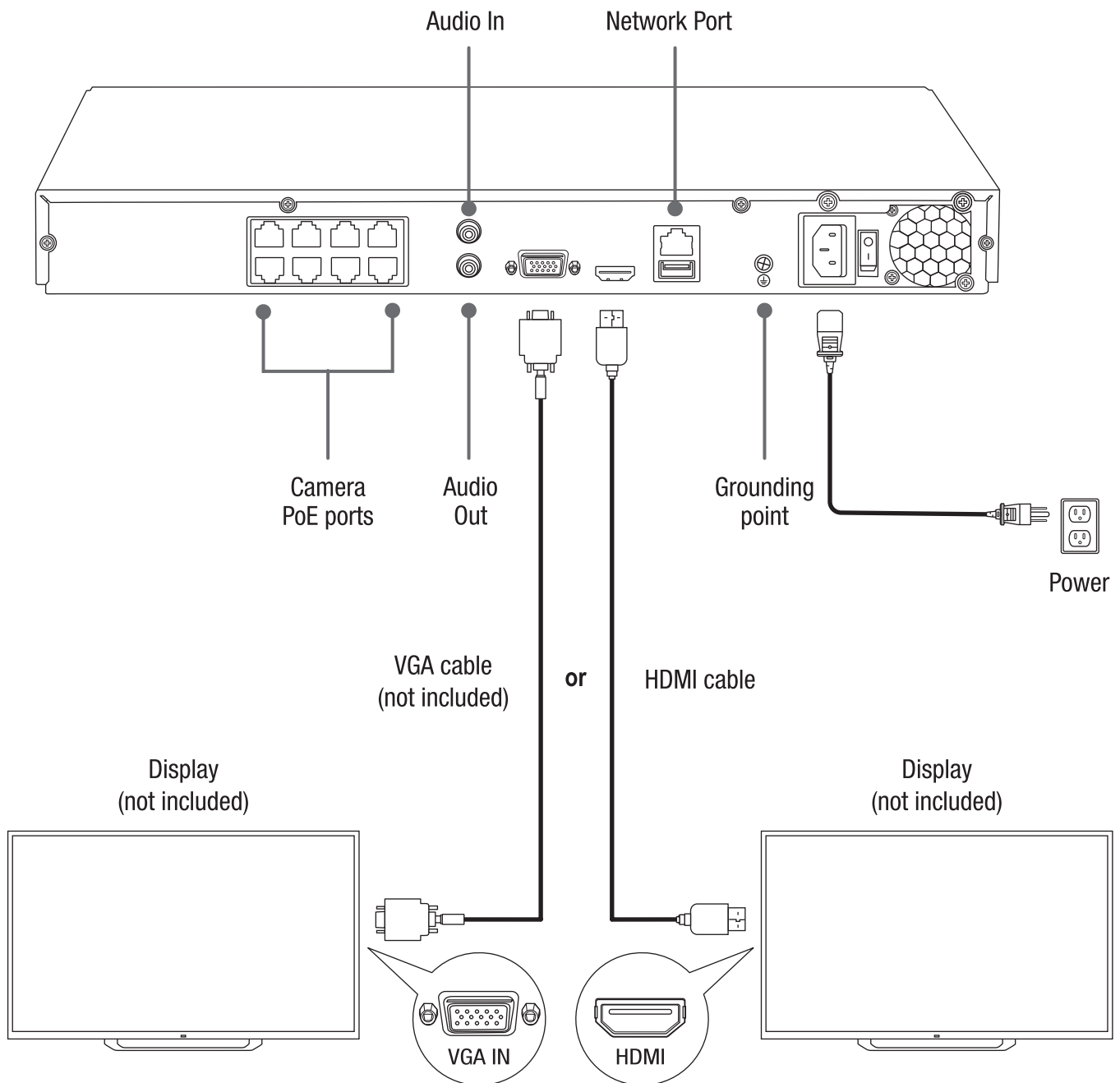

**Note:** The following installation steps support a stand alone setup WITHOUT a wired connection to a network. If it is desired to setup the NVR with a wired network connection (for remote access to NVR over the internet), proceed to the User's Guide for the appropriate setup steps (do not continue with this quick setup).

## 2.1 Hard Drive Installation

### Note:

- Static electricity can damage the TV-NVR408/TV-NVR416. Before handling the unit, discharge any static electricity, or use an anti-static wrist strap.
- The TV-NVR408/TV-NVR416 supports SATA I, II, and III drives.

1. Remove the retaining screws from the the top panel of the TV-NVR408/TV-NVR416.

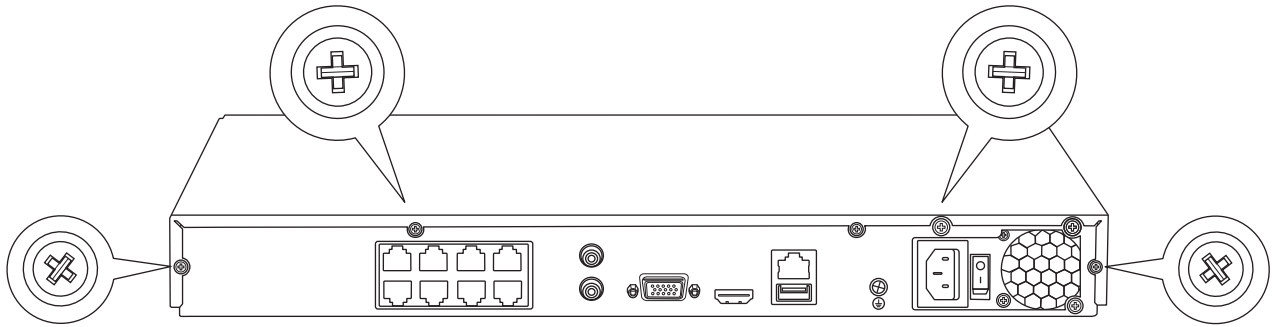

2. Slide the cover off the unit by pulling the top cover towards the rear panel.

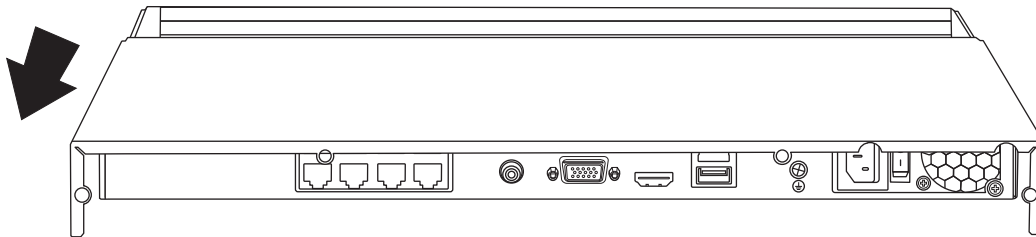

- 3.** Attach the SATA data and power cables to the hard disc drive, then connect the SATA cable and the molex connect or the control board.

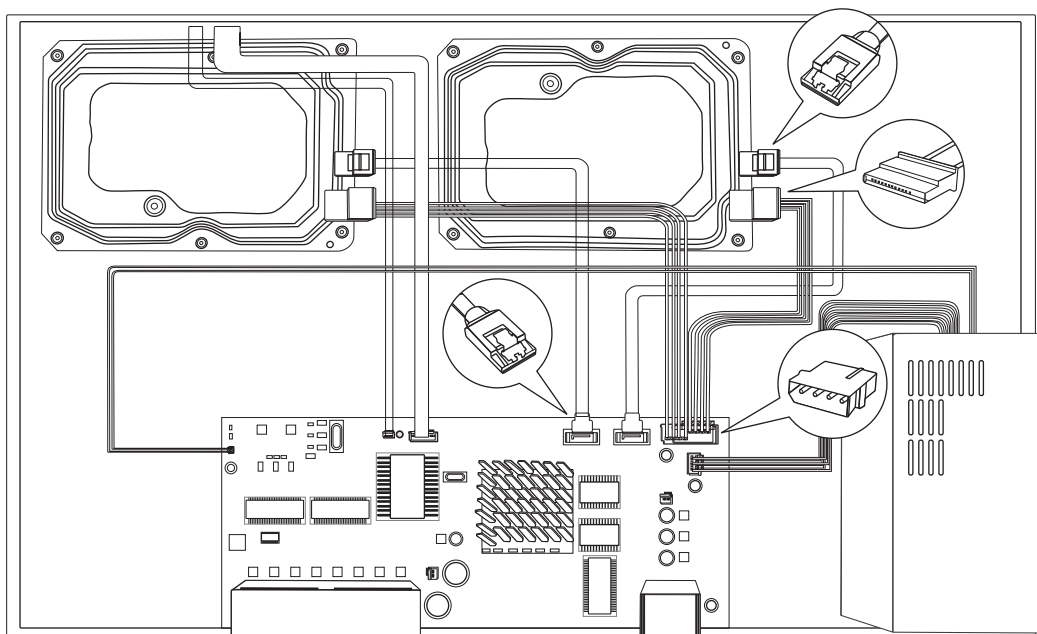

- 4.** Mount the hard drives to the drive bays of the TV-NVR408/TV-NVR416 using the 4 mounting screws, screwing from the underside of the TV-NVR408/TV-NVR416 into the hard drive case.

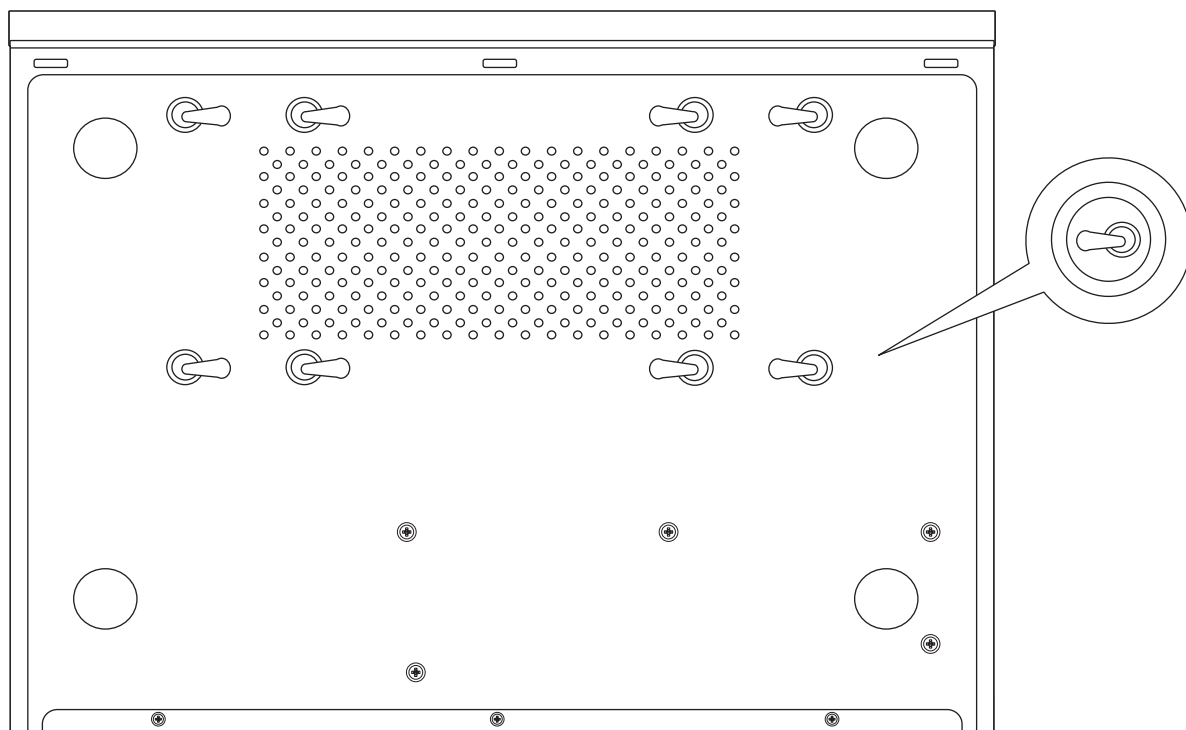

- 5.** Slide the top cover back on the TV-NVR408/TV-NVR416, and reinstall the screws holding the panel in place.

## 2.2 Hardware Installation

1. Connect an HDMI cable or a VGA cable (**sold separately**) from your display to the TV-NVR408/TV-NVR416's HDMI or VGA port on the rear panel.

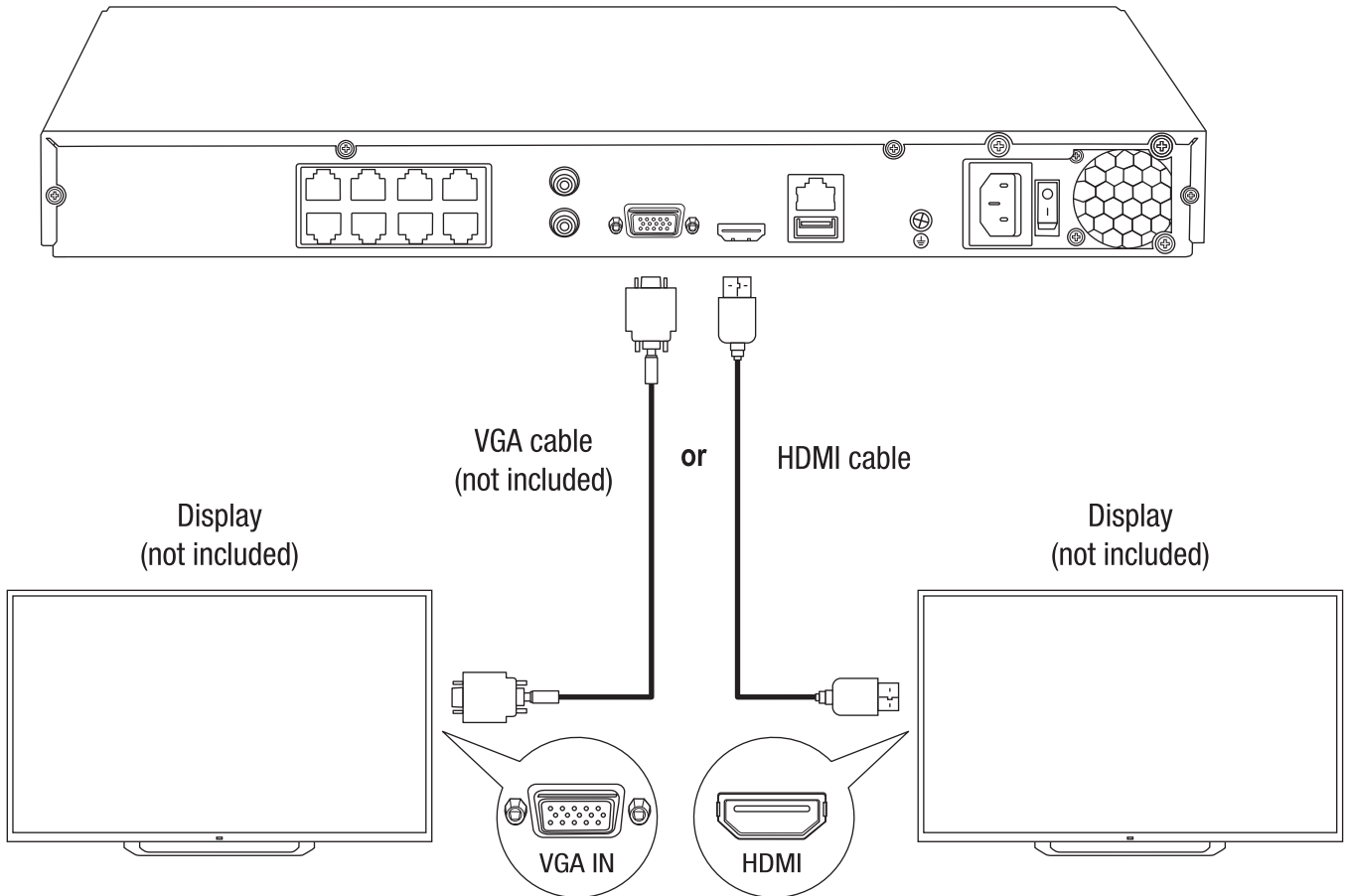

2. Connect the included mouse to the front or rear USB port on the TV-NVR408/TV-NVR416.

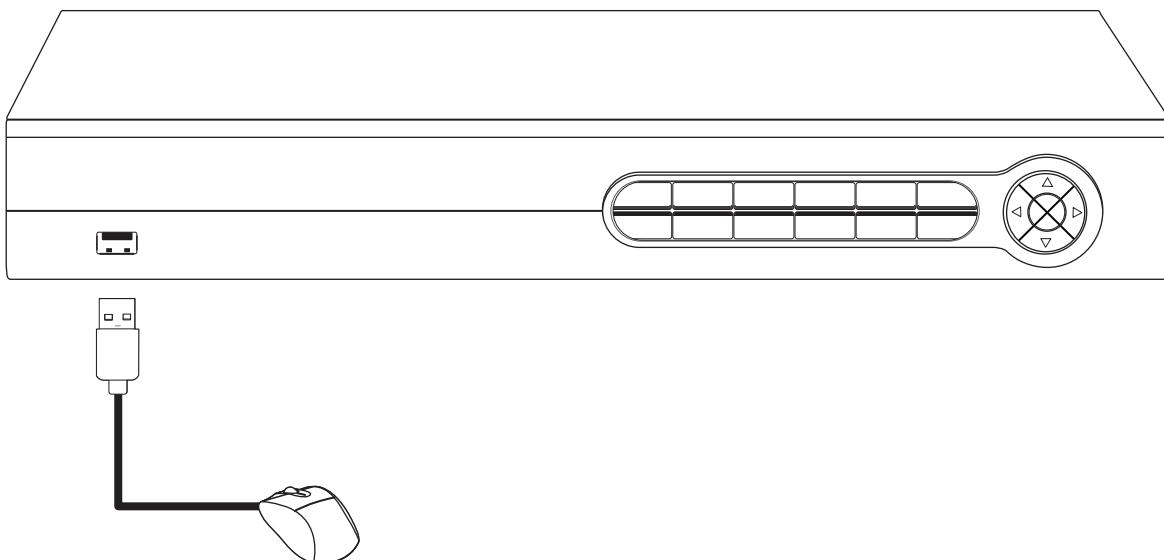

3. Attach the power cord (rear panel) and plug the unit into an electrical outlet.

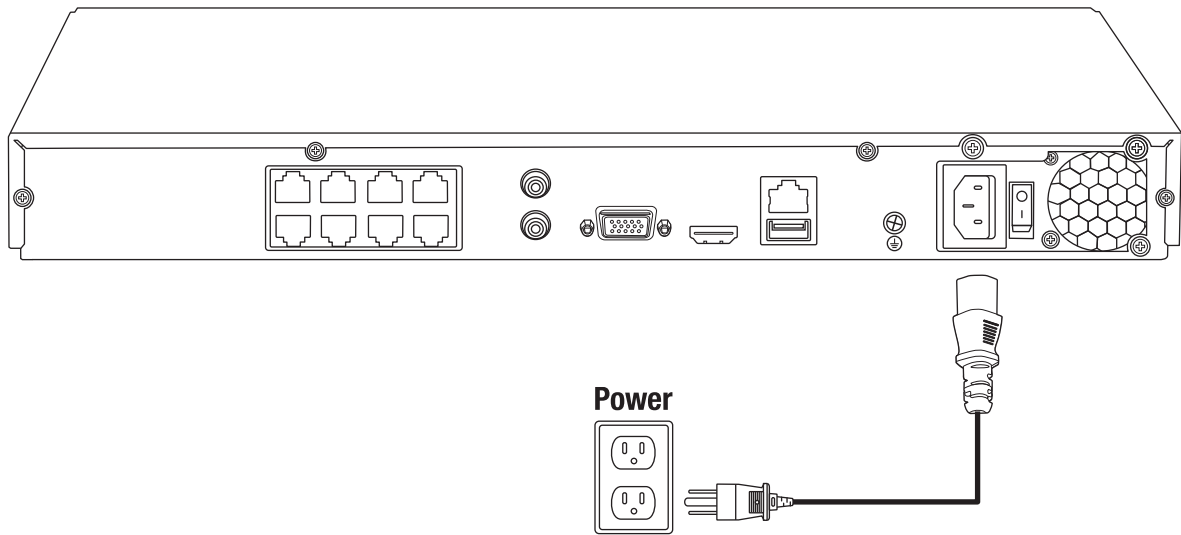

4. Toggle the power switch located on the rear panel to the **On** position.

5. Turn the power switch on, connect a TRENDnet PoE camera (i.e. TV-IP314PI) to any of the PoE network ports on the back of the TV-NVR408/TV-NVR416.

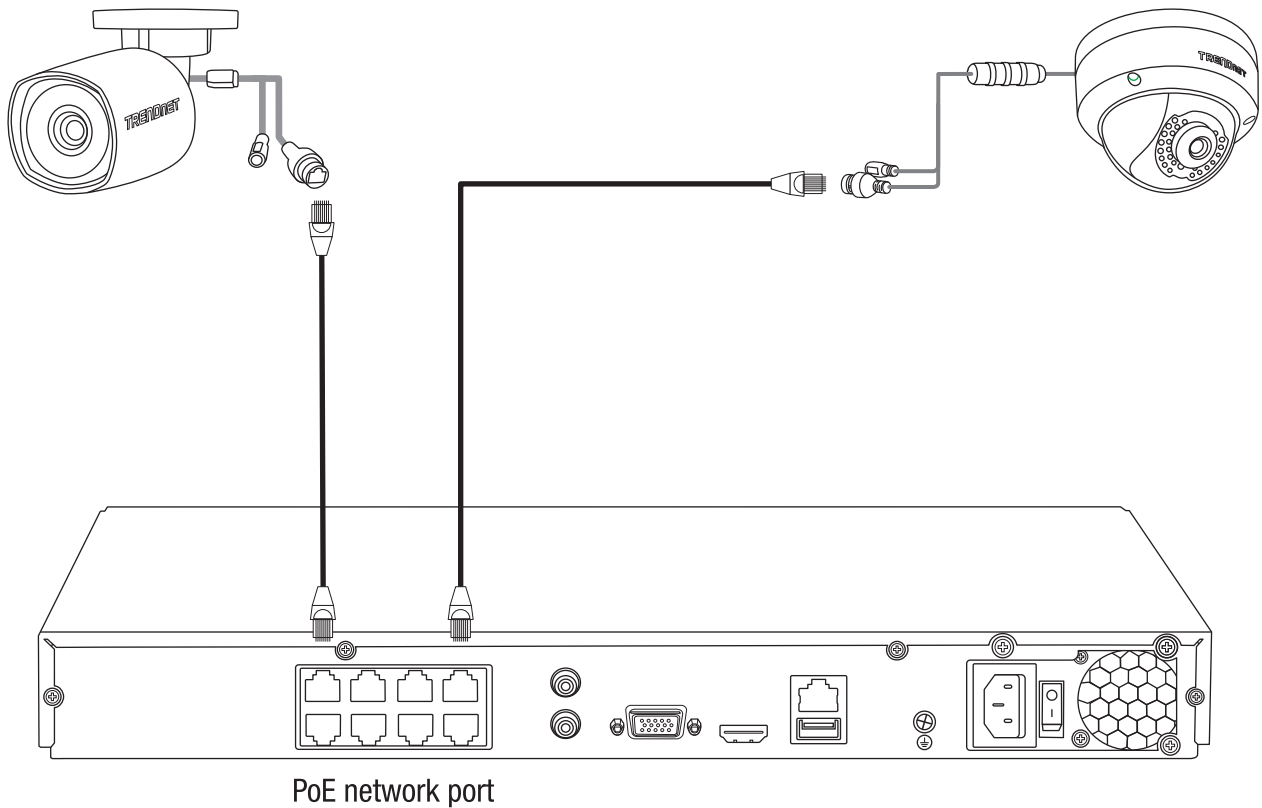



## 2.3 System Setup

1. If you are accessing the NVR the first time, please activate the device by following the password setup.

Set Password

User Name	admin
New Password	
Confirm Passw...	

Valid password range [8-16]. You can use a combination of numbers, lowercase, uppercase and special character for your password with at least two kinds of them contained.

OK Cancel

OK

2. For the next window saying “The device is now activated, would you like to export the password file for reset purpose in the future?” You can select **Yes** or **No** to proceed.

Attention

? The device is now activated, would you like to export the password file for reset purpose in the future?

Yes No

No

3. Create the unlock pattern for quick access later.

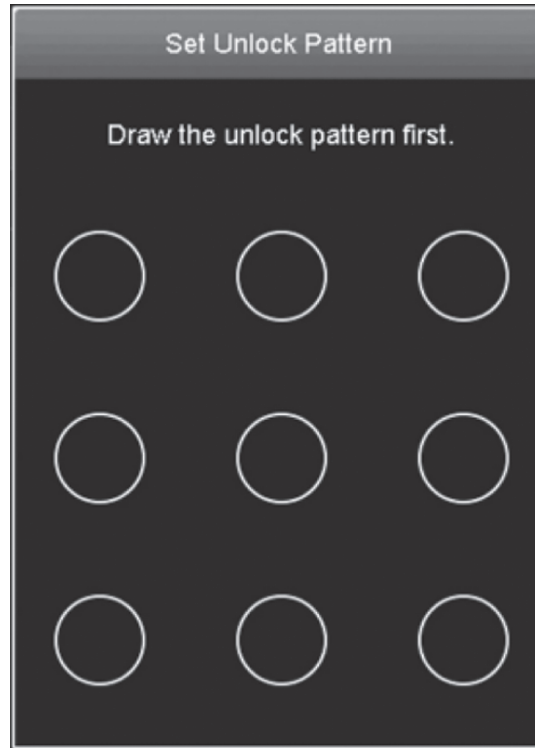

4. Select Language and click **Apply** to continue.

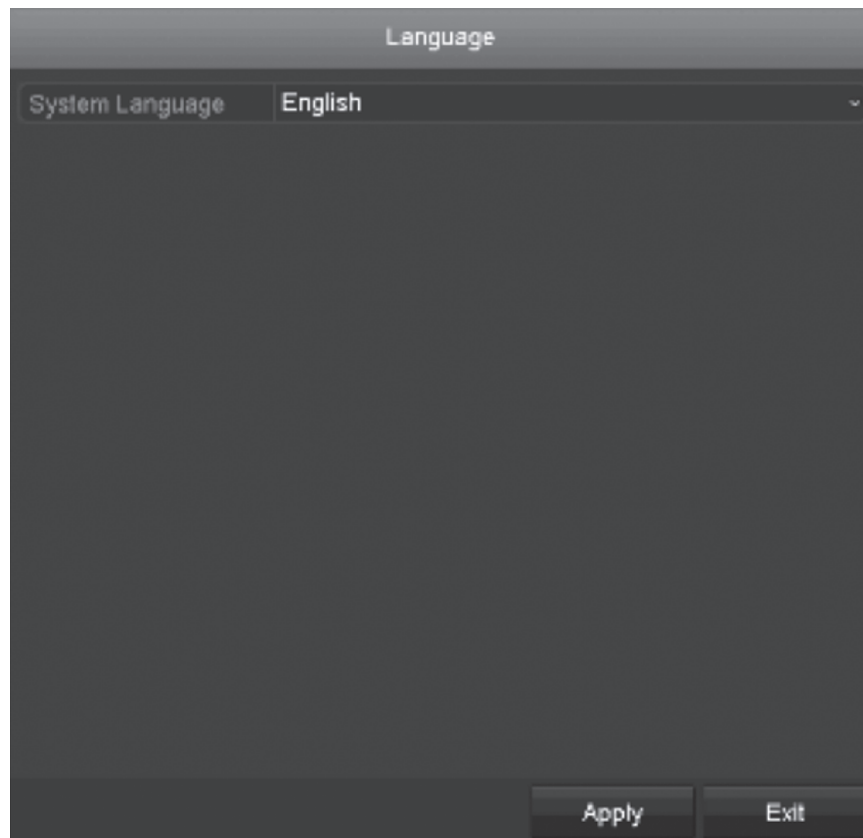

**Apply**

5. Uncheck “Start wizard when device starts?” to skip the setup process each time the TV-NVR408 is powered up (optional) then click “**Next**”.

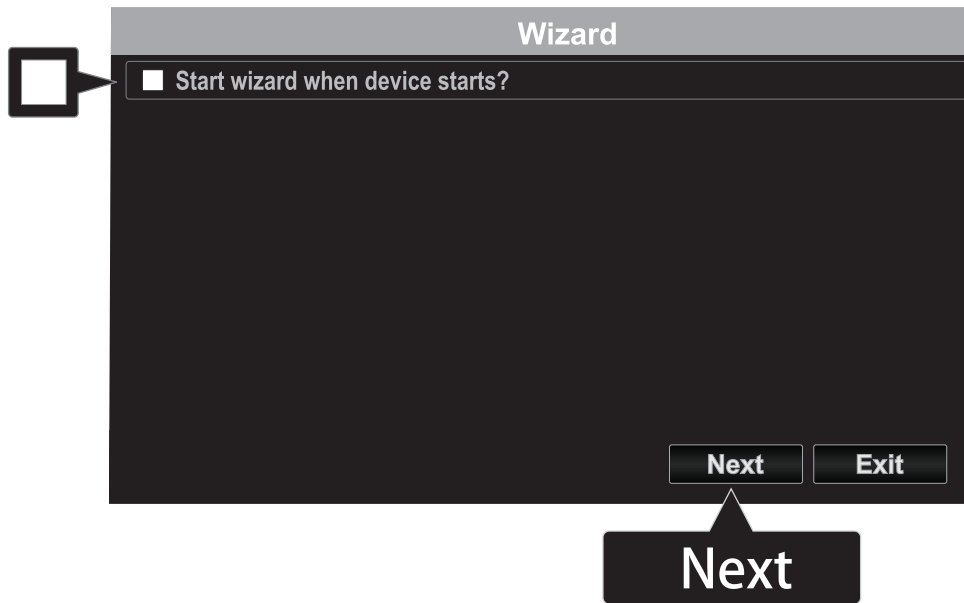

6. Configure network settings for the unit and click **Next**.

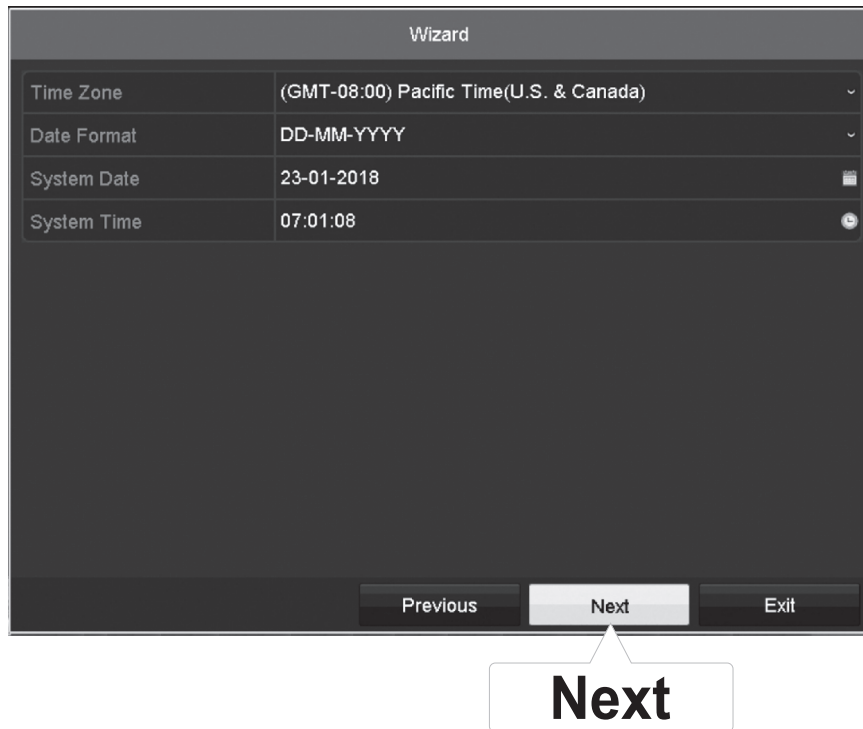

7. Configure port settings for the unit and click **Next**.

Wizard	
Network Type	10/100/1000 Self-adaptive
Enable DHCP Client	<input checked="" type="checkbox"/>
IPv4 Address	192 . 168 . 32 . 105
IPv4 Subnet Mask	255 . 255 . 255 . 0
IPv4 Default Gateway	192 . 168 . 32 . 1
Enable Obtain DNS Serv...	<input checked="" type="checkbox"/>
Primary DNS Server	192.168.32.1
Secondary DNS Server	
Internal NIC IPv4 Address	192 . 168 . 254 . 1

Previous Next Exit

**Next**

8. Configure and add cameras to the unit and click **Next**.

Wizard	
Server Port	8000
HTTP Port	80
RTSP Port	554
Enable UPnP	<input checked="" type="checkbox"/>
Enable DDNS	<input type="checkbox"/>
DDNS Type	dyn.com
Server Address	
Device Domain Name	
Status	DDNS is disabled.
UserName	
Password	

Previous Next Exit

**Next**

9. Select which hard drive you want to record to. (Initialize and format if necessary), then click “OK”.

**Note:** For further information about recording to a secondary hard drive, please refer to the User's Guide.

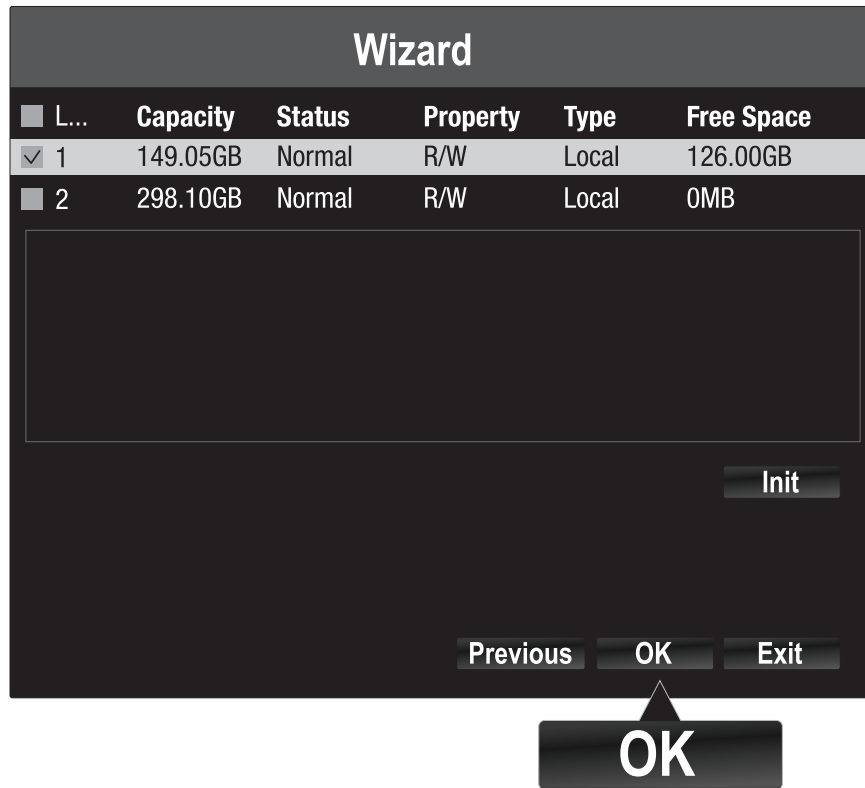

10. Add your cameras from your network and click “Next”

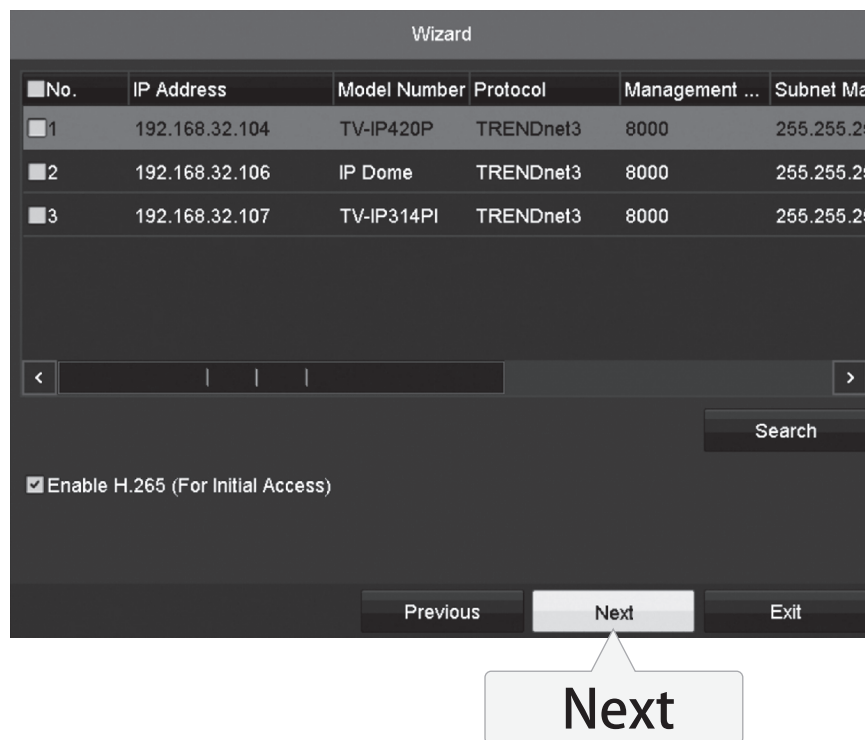

The hardware setup is complete and you will enter **Live View**. For detail information please refer to the User's Guide.

### 3. Start Recording

1. In Live View, use the mouse and right click anywhere on the screen.



2. A short menu will show up. Choose **Start Recording** and click **Continuous Record**.

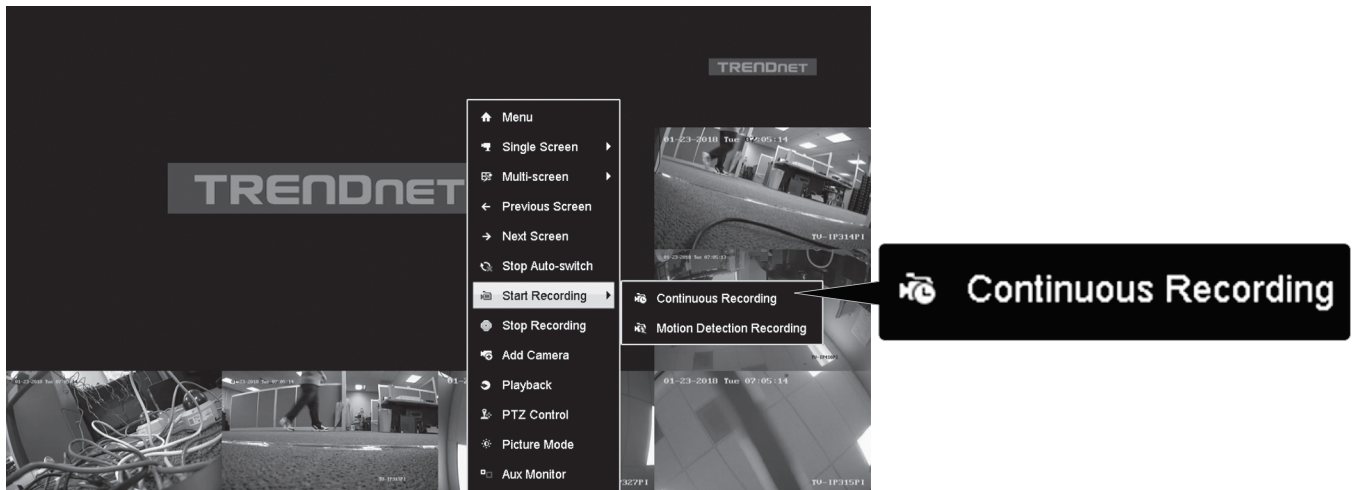

3. Click **Yes** to confirm continuous recording. (For more advanced video recording features, please see the User's Guide for more details.)

## 4. Instant Playback

1. In Live View, click (left button) on the display you want to playback.

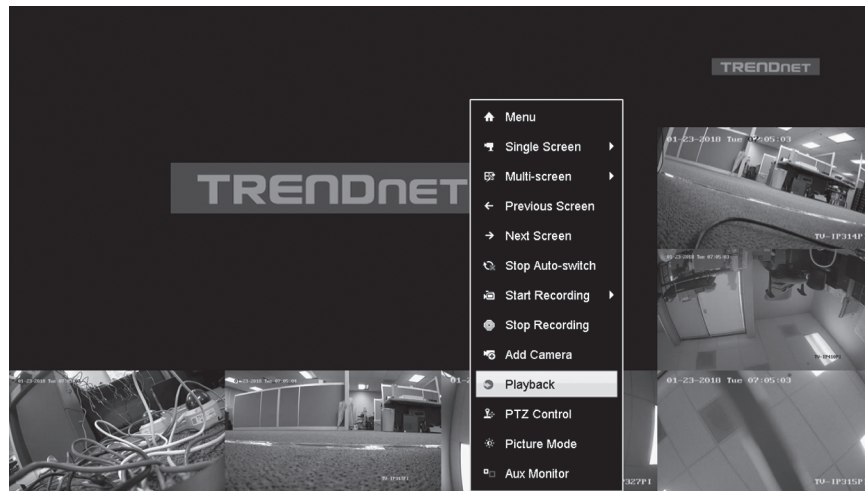

2. Click on “Instant Playback” to play back the last 5 minutes of recording.

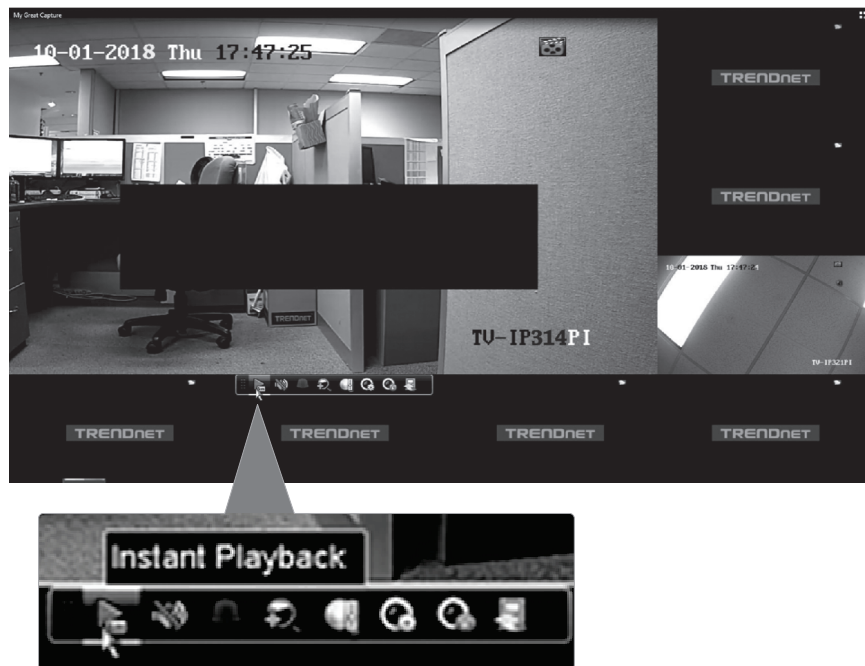

Please see the User's Guide for more advanced video playback features.



# Declaration of Conformity

TRENDNET<sup>®</sup>

## Manufacturer's Name and Address

TRENDnet, Inc.  
20675 Manhattan Place  
Torrance, CA 90501 USA

Zwolsestraat 156 2587 WB  
The Hague The Netherlands



## Product Information:

**Model Number:** TV-NVR408 / TV-NVR416  
**Product Name:** 8-Channel H.265 1080p HD PoE+ NVR  
16-Channel H.265 1080p HD PoE+ NVR  
**Trade Name:** TRENDnet

TRENDnet hereby declare that the product is in compliance with the essential requirements and other relevant provisions under our sole responsibility.

**Safety** EN 60950-1: 2006 + A11: 2009: + A1: 2010 + A12: 2011 + A2: 2013

**EMC** EN 55022: 2010 Class B  
EN 50130-4: 2011  
EN 61000-3-2: 2006 + A1: 2009 + A2: 2009  
EN 61000-3-3: 2008

This product is herewith confirmed to comply with the Directives.

**Directives:** LVD Directive 2014/35/EU  
EMC Directive 2014/30/EU  
RoHS Directive 2011/65/EU  
WEEE Directive 2012/19/EU  
REACH Regulation (EC) No. 1907/2006

Person responsible for this declaration.  
Place of Issue: Torrance, California, USA  
Date: April 23, 2019  
Name: Sonny Su  
Title: Director of Technology

Signature:

A handwritten signature in black ink, appearing to read 'Sonny Su', is written over a horizontal line.





## Certifications

This device can be expected to comply with Part 15 of the FCC Rules provided it is assembled in exact accordance with the instructions provided with this kit. Operation is subject to the following conditions:  
(1) This device may not cause harmful interference  
(2) This device must accept any interference received including interference that may cause undesired operation.



Waste electrical and electronic products must not be disposed of with household waste. Please recycle where facilities exist. Check with your Local Authority or Retailer for recycling advice.

Applies to PoE Products Only: This product is to be connected only to PoE networks without routing to the outside plant.

## Note

The Manufacturer is not responsible for any radio or TV interference caused by unauthorized modifications to this equipment. Such modifications could void the user's authority to operate the equipment.

## Advertencia

En todos nuestros equipos se mencionan claramente las características del adaptador de alimentación necesario para su funcionamiento. El uso de un adaptador distinto al mencionado puede producir daños físicos y/o daños al equipo conectado. El adaptador de alimentación debe operar con voltaje y frecuencia de la energía eléctrica domiciliar existente en el país o zona de instalación.

## Technical Support

If you have any questions regarding the product installation, please contact our Technical Support.  
Toll free US/Canada: **1-866-845-3673**  
Regional phone numbers available  
at [www.trendnet.com/support](http://www.trendnet.com/support)

## Product Warranty Registration

Please take a moment to register your product online. Go to TRENDnet's website at:  
**[www.trendnet.com/register](http://www.trendnet.com/register)**

## TRENDnet

20675 Manhattan Place  
Torrance, CA 90501  
USA